



# INSTALLATION INSTRUCTIONS

## 50 Ohm MONOBLOCK CONNECTORS

Kabelwerk | **EUPEN** AG

E 1028 - Rev 03 - 05.09.06

cable

### 7/8", 1 1/4" & 1 5/8" MONOBLOCK CONNECTORS - O-Ring type

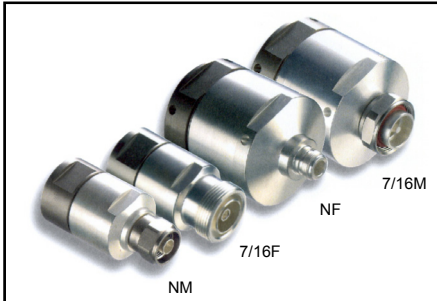

<b>7/8"</b>	<b>SPTC50AV78M / US: F-78</b>
<b>7/8"X</b>	<b>SPTC50AV78X</b>
<b>1 1/4"</b>	<b>SPTC50AV114M / US: F-114</b>
<b>1 1/4"X</b>	<b>SPTC50AV114X</b>
<b>1 5/8"</b>	<b>SPTC50AV158M / US: F-158</b>

Please use cable preparation tools and refer to its instructions for use.

Follow the instruction process below only if these tools are not available.

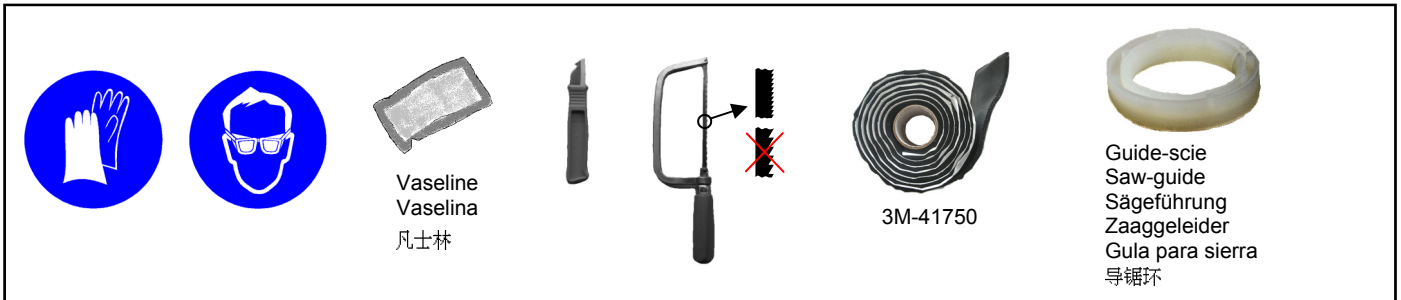

	<b>NM</b>	<b>7/16M</b>	<b>7/8"</b>		<b>1 1/4"</b>		<b>1 5/8"</b>	
	19 mm	32 mm		30 mm				
					1-11/16"	φ 4 mm φ 48 mm	2-1/4"	φ 5 mm φ 63 mm

#### MANUAL METHOD

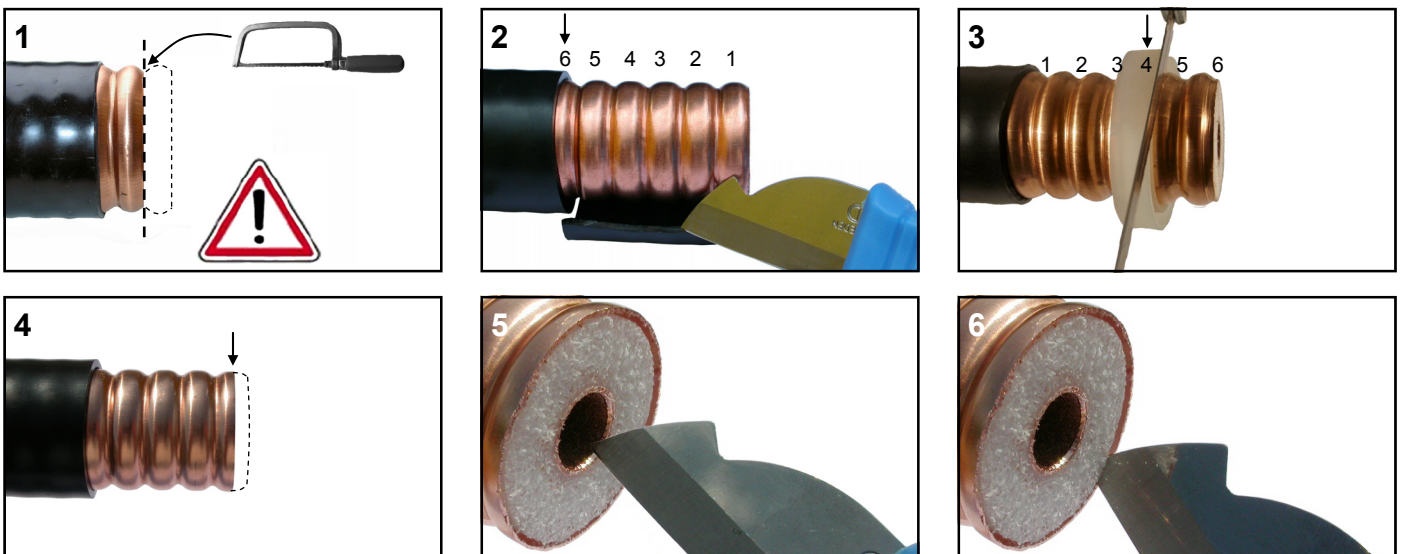



# INSTALLATION INSTRUCTIONS

## 50 Ohm MONOBLOCK CONNECTORS

Kabelwerk **EUPEN** AG

E 1028 - Rev 03 - 05.09.06

cable

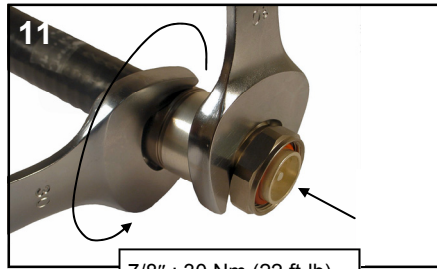
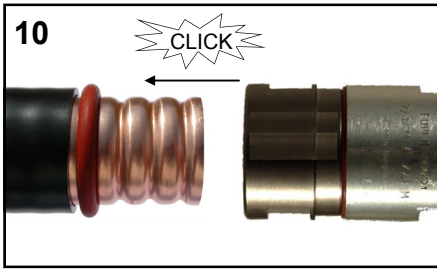
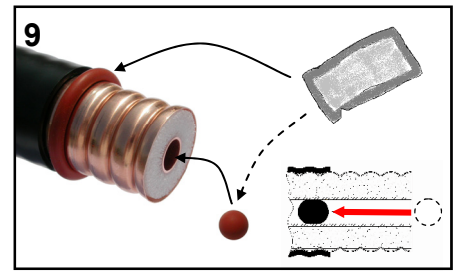
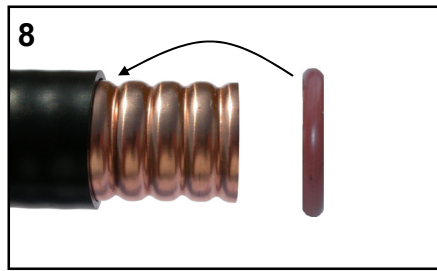
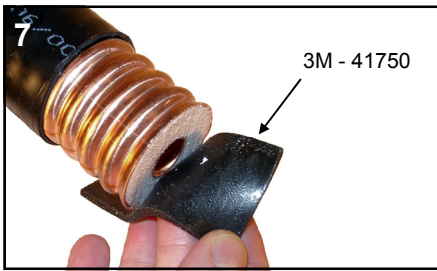

7/8" : 30 Nm (22 ft-lb)  
1 1/4" : 40 Nm (29 ft-lb)  
1 5/8" : 50 Nm (37 ft-lb)

For any questions please contact KABELWERK EUPEN AG / for US Customer service call 1-800-419-5100

**NOTICE:**  
KABELWERK EUPEN AG disclaims any liability or responsibility for the results of improper or unsafe installation practices.

**AVIS:**  
KABELWERK EUPEN AG décline toute responsabilité en cas de non respect de ces instructions.

**WAARSCHUWING:**  
KABELWERK EUPEN AG wijst elke verantwoordelijkheid van de hand in geval van het niet opvolgen van deze aanbevelingen.

**BEMERKUNG:**  
KABELWERK EUPEN AG lehnt jede Verantwortung bei Nichtbeachtung dieser Instruktionen ab.

**AVISO:**  
KABELWERK EUPEN AG rehusa todas las responsabilidades en caso de no respetar las instrucciones.

**注意:**  
本公司声明对于不恰当或不安全的安装, 检验, 维修或拆卸操作所导致的后果不承担任何义务和责任。





# INSTALLATION INSTRUCTIONS

## 50 Ohm MONOBLOCK CONNECTORS

Kabelwerk



**EUPEN** AG

E 1029 - Rev 04 - 12.10.06

cable

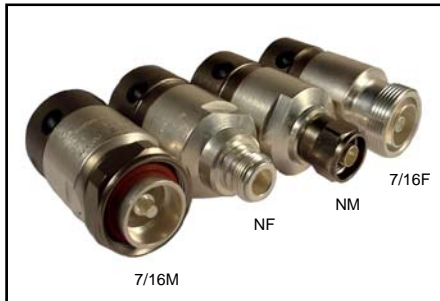
### 7/8", 1 1/4" & 1 5/8" MONOBLOCK CONNECTORS - Sealant type





	
<b>7/8"</b>	<b>SPTC50AV78M / US: F-78</b>
<b>7/8"X</b>	<b>SPTC50AV78X</b>
<b>1 1/4"</b>	<b>SPTC50AV114M / US: F-114</b>
<b>1 1/4"X</b>	<b>SPTC50AV114X</b>
<b>1 5/8"</b>	<b>SPTC50AV158M / US: F-158</b>

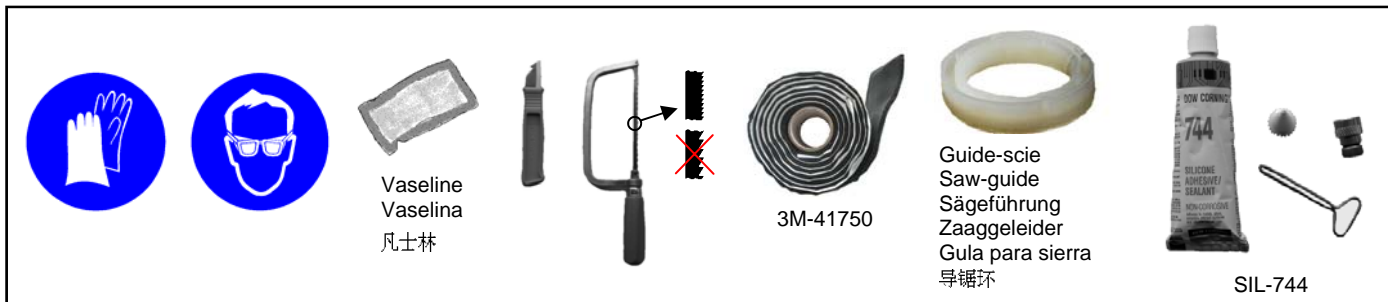

Please use cable preparation tools and refer to its instructions for use.



Follow the instruction process below only if these tools are not available.



	<b>NM</b>	<b>7/16M</b>
	19 mm	32 mm

<b>7/8"</b>	
	30 mm

<b>1 1/4"</b>	
	1-11/16"
	φ 4 mm φ 48 mm

<b>1 5/8"</b>	
	2-1/4"
	φ 5 mm φ 63 mm

#### MANUAL METHOD

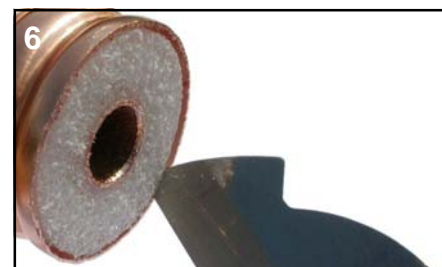
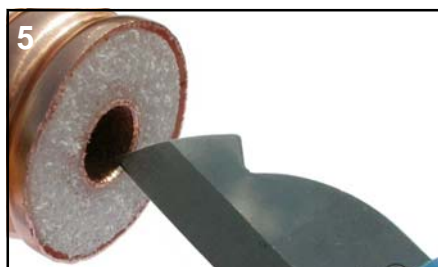
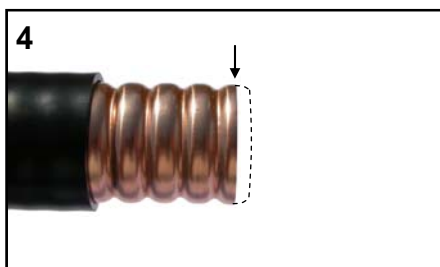
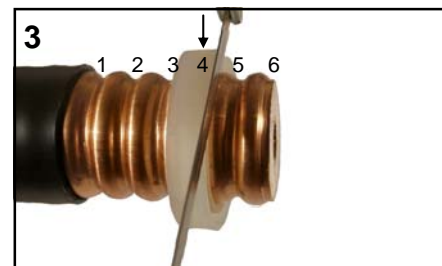
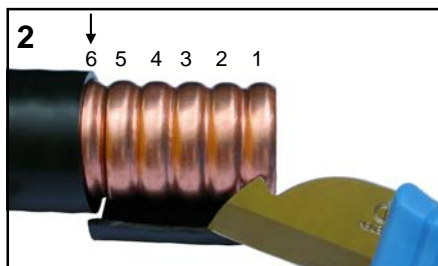
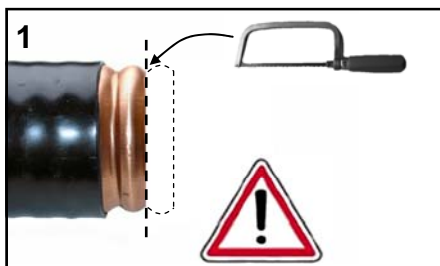



# INSTALLATION INSTRUCTIONS

## 50 Ohm MONOBLOCK CONNECTORS

Kabelwerk

**EUPEN** AG

E 1029 - Rev 04 - 12.10.06

cable

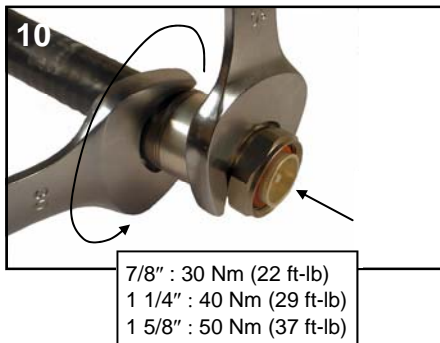
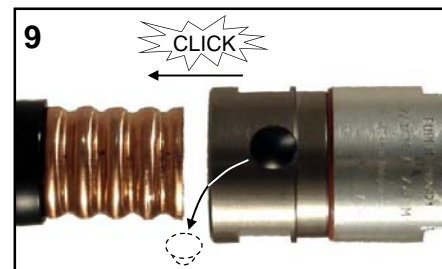
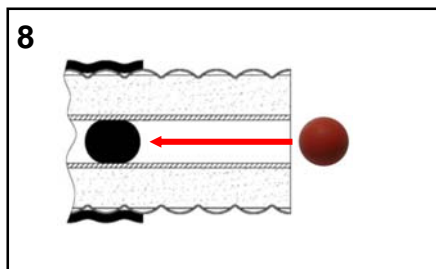
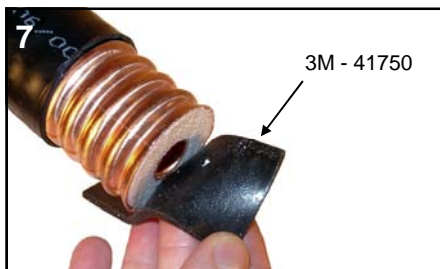

7/8" : 30 Nm (22 ft-lb)  
1 1/4" : 40 Nm (29 ft-lb)  
1 5/8" : 50 Nm (37 ft-lb)

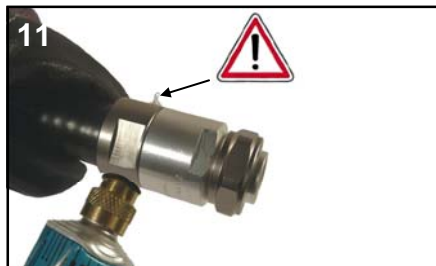

For any questions please contact KABELWERK EUPEN AG / for US Customer service call 1-800-419-5100

**NOTICE:**  
KABELWERK EUPEN AG disclaims any liability or responsibility for the results of improper or unsafe installation practices.

**AVIS:**  
KABELWERK EUPEN AG décline toute responsabilité en cas de non respect de ces instructions.

**WAARSCHUWING:**  
KABELWERK EUPEN AG wijst elke verantwoordelijkheid van de hand in geval van het niet opvolgen van deze aanbevelingen.

**BEMERKUNG:**  
KABELWERK EUPEN AG lehnt jede Verantwortung bei Nichtbeachtung dieser Instruktionen ab.

**AVISO:**  
KABELWERK EUPEN AG rehusa todas las responsabilidades en caso de no respetar las instrucciones.

**注意:**  
本公司声明对于不恰当或不安全的安装, 检验, 维修或拆卸操作所导致的后果不负任何义务和责任。

